

Capacidade de Carga - Load Capacity - Capacidad de carga

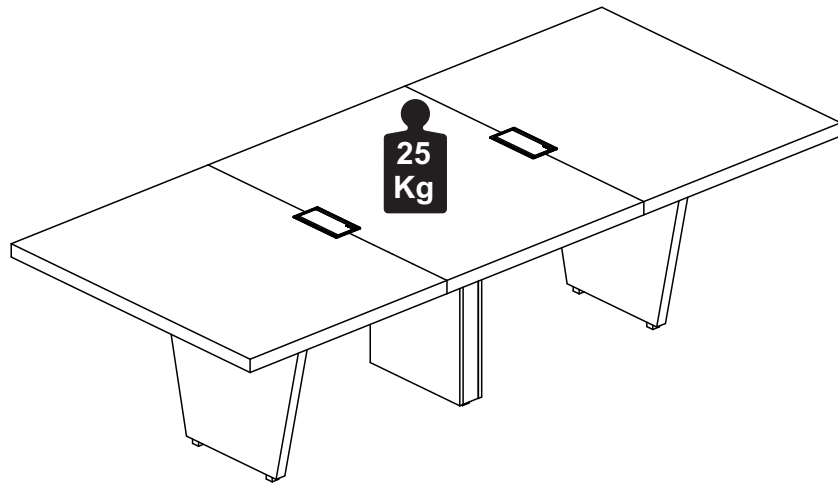

Manutenção e Limpeza

Vidros: pano levemente umedecido com álcool, seguido de pano seco.
Madeiras: pano levemente umedecido com água, seguido de pano seco.
*Nunca utilizar produtos químicos ou abrasivos.

Maintenance and Cleaning

Glasses: cloth lightly moistened with alcohol, followed by dry cloth.
Woods: cloth slightly moistened with water, followed by cloth seco.
*Never use chemicals or abrasives.

Mantenimiento y Limpieza

Vidrios: legeramente humedecido con alcohol, seguido de un paño seco.
Madera: ligeramente humedecido con agua, seguido de un paño seco.
*No utilice nunca productos quimicos o abrasivos.

INSTRUÇÕES DE MONTAGEM ASSEMBLY INSTRUCTIONS INSTRUCCIONES DE MONTAJE

MESAS TABLES TABLAS

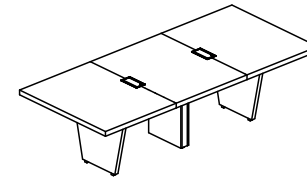

REF. #EDG2712

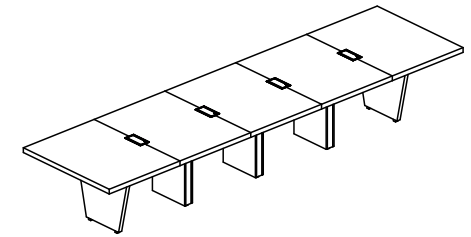

REF. #EDG4512

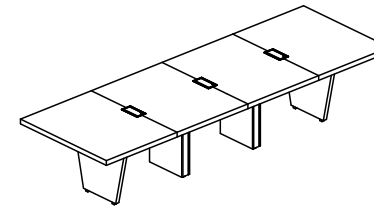

REF. #EDG3612

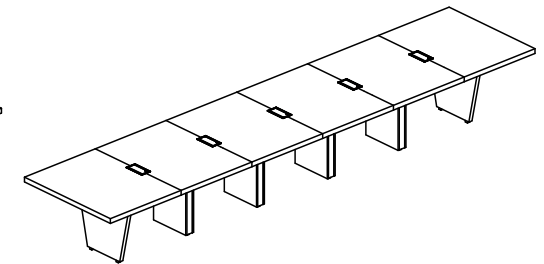

REF. #EDG5412



 **GEBB WORK**
MOBILIÁRIO PARA ESCRITÓRIO

GEBB Work Ind. de Móveis Ltda.
Rua Beatriz Dall'Onder, 120
Distrito Industrial

95706-350 - Bento Gonçalves - RS - Brasil
Fone: (0XX54) 3454-1105 Fax: (0XX54) 3453-1407
Phone: (0XX54) 3454-1105 Fax: (0XX54) 3453-1407
E-mail: pedidos@gebbwork.com.br
www.gebbwork.com.br

LISTA DE PEÇAS

- 01 - Painel Lateral Esquerdo/Direito
- 02 - Tampo
- 03 - Painel Frontal
- 04 - Travessa Inferior
- 05 - Tampo Central
- 06 - Painel Central

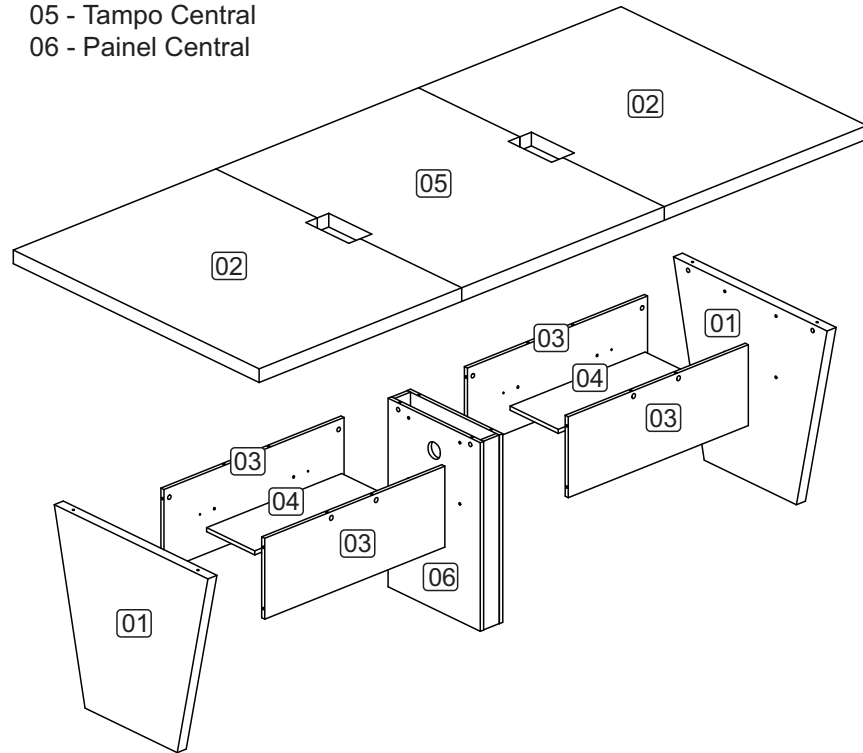

LISTA DE PIEZAS

- 01 - Panel Lateral Izquierdo/Derecho
- 02 - Tapa
- 03 - Panel Delantero
- 04 - Panel Inferior
- 05 - Tapa Central
- 06 - Panel Central

PARTS IDENTIFICATION

- 01 - Panel Side Left/Right
- 02 - Top
- 03 - Front Panel
- 04 - Lower Panel
- 05 - Center Top
- 06 - Center Panel

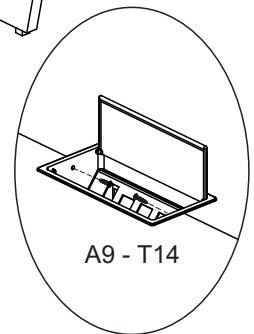
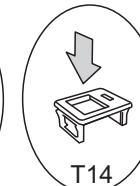
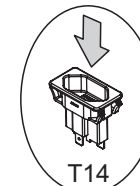
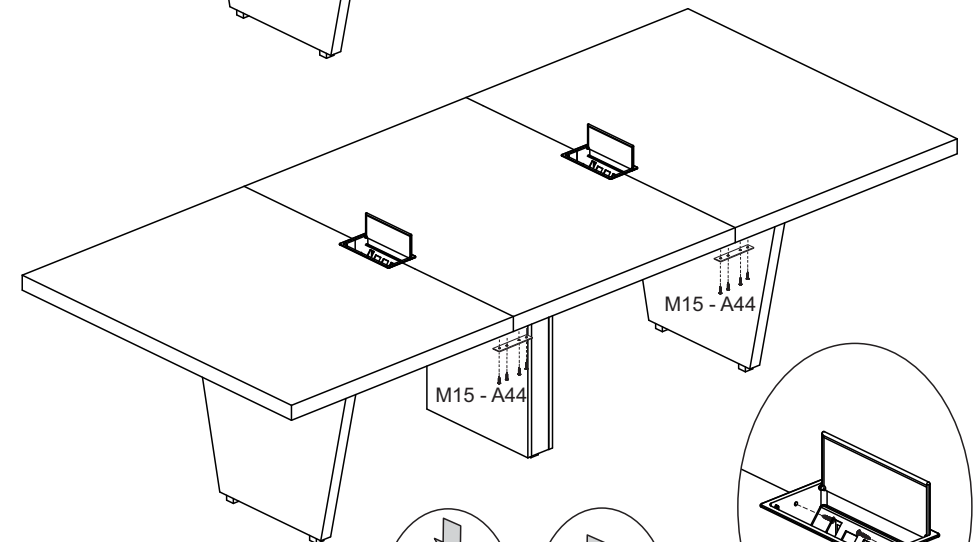
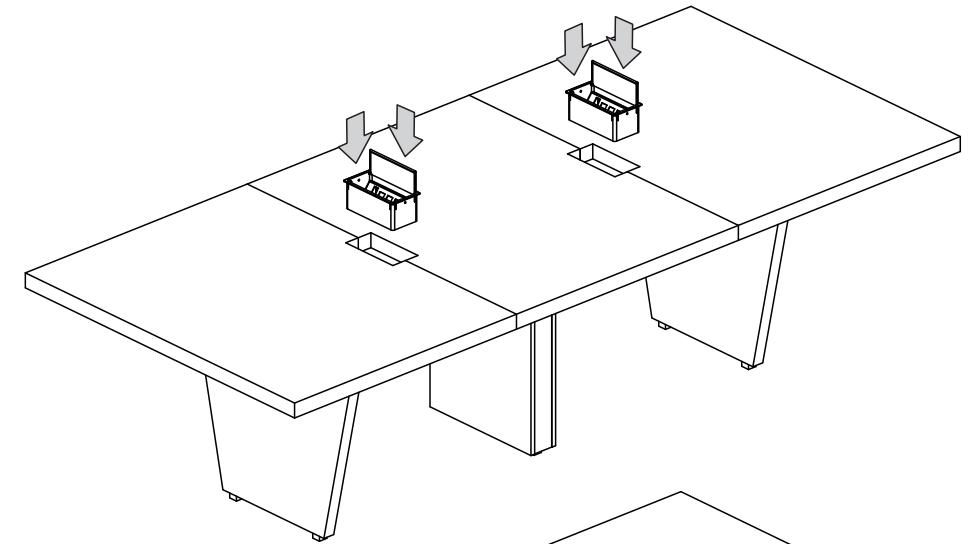

*Encaixar até ouvir o "clik"

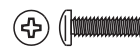

A44 - 32x



M15 - 8x



T9 - 2x



T14 - 2x

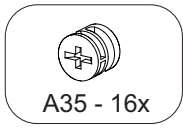
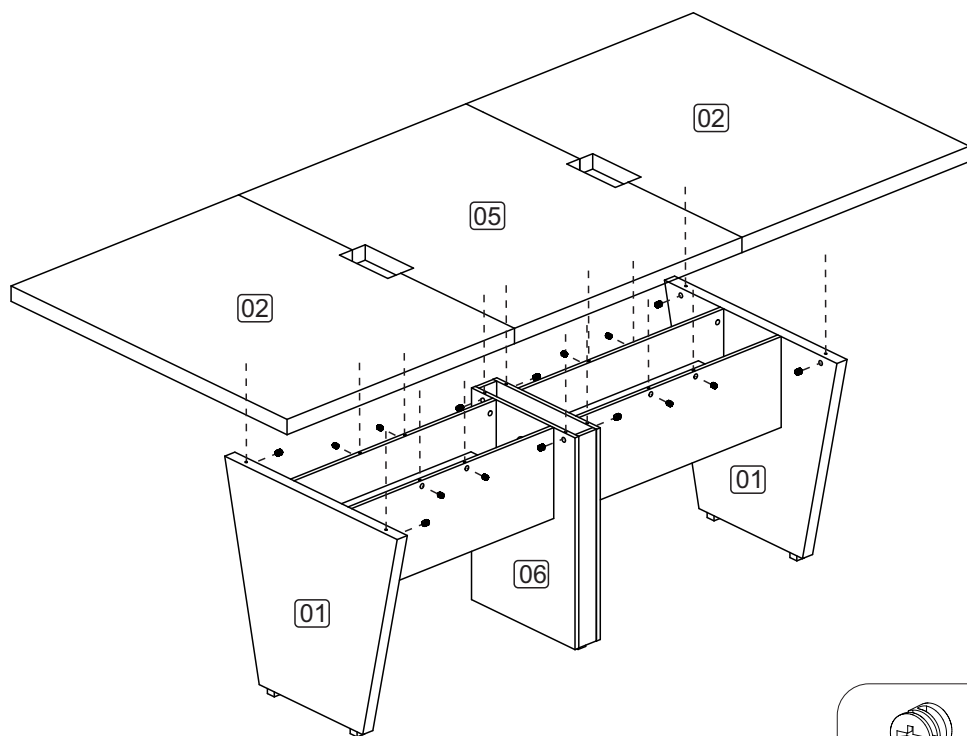
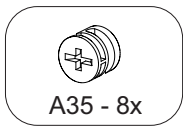
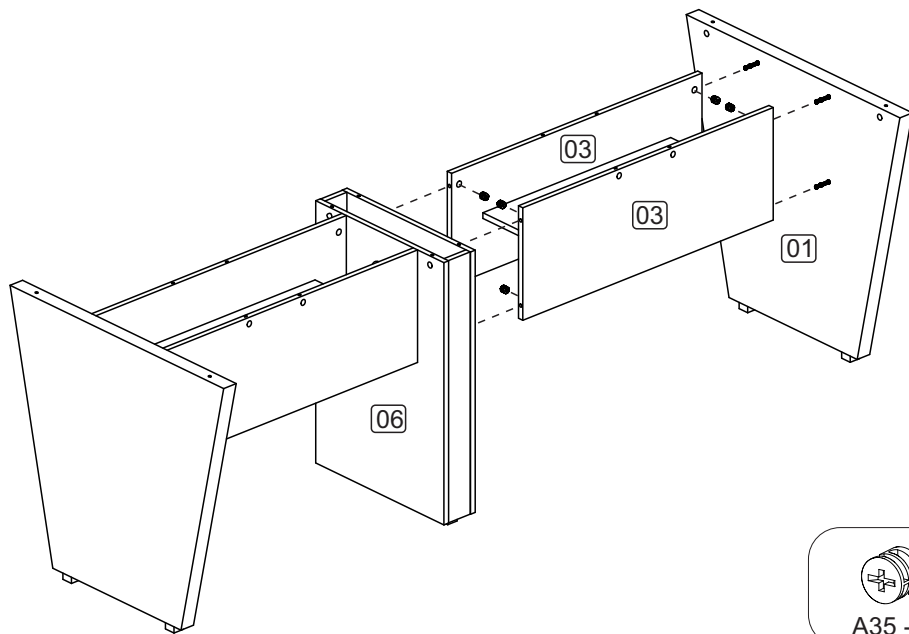

ACESSÓRIOS ACCESSORIES ACCESORIOS

REF. #EDG2712

A29 - PARAF. MINIFIX
M6x33mm **20x**

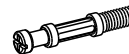

A32 - PARAF. MINIFIX
4x

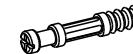

A35 - TAMBOR
MINIFIX **20x**



A36 - BUCHA M6x13
20x



A44 - PARAF. M6x16 CP
16x



D1 - CAVILHA 8x30
4x

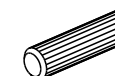

L7 - SAPATA ALUMÍNIO
30x30x20mm **4x**



M15 - CHAPA 04 FUROS
127x3/4x4x1/8ZB **4x**

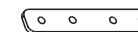

T9 - CAIXA DE TOMADA
PLÁSTICA **1x**

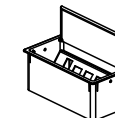

T14 - KIT P/CAIXA DE
TOMADA **1x**

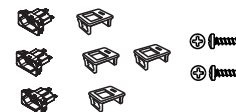

*O tipo de ferragens para as mesas EDG3612 / EDG4512 e EDG5412 será o mesmo, porém a quantidade será maior, de acordo com a quantidade de pés centrais e tampos.

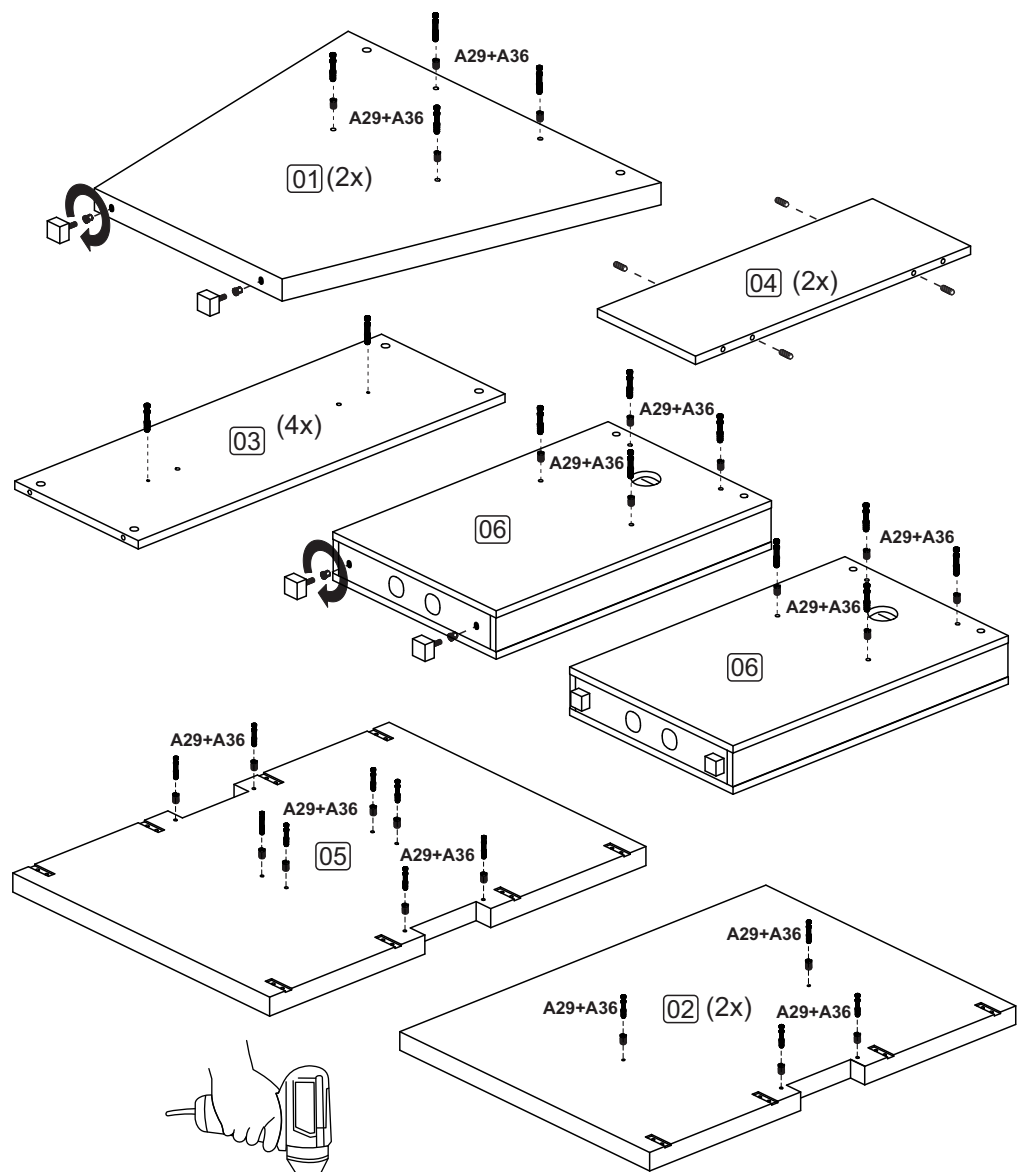

Usar ponta de parafusadeira sextavada

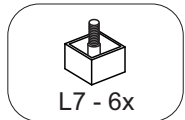
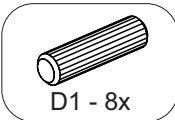
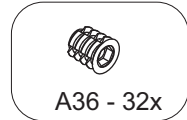
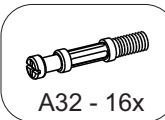
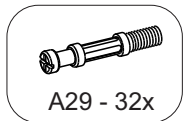
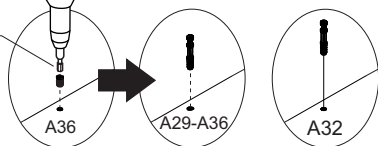

2x

